

K6 Professional Barista

Updated 13/04/2022

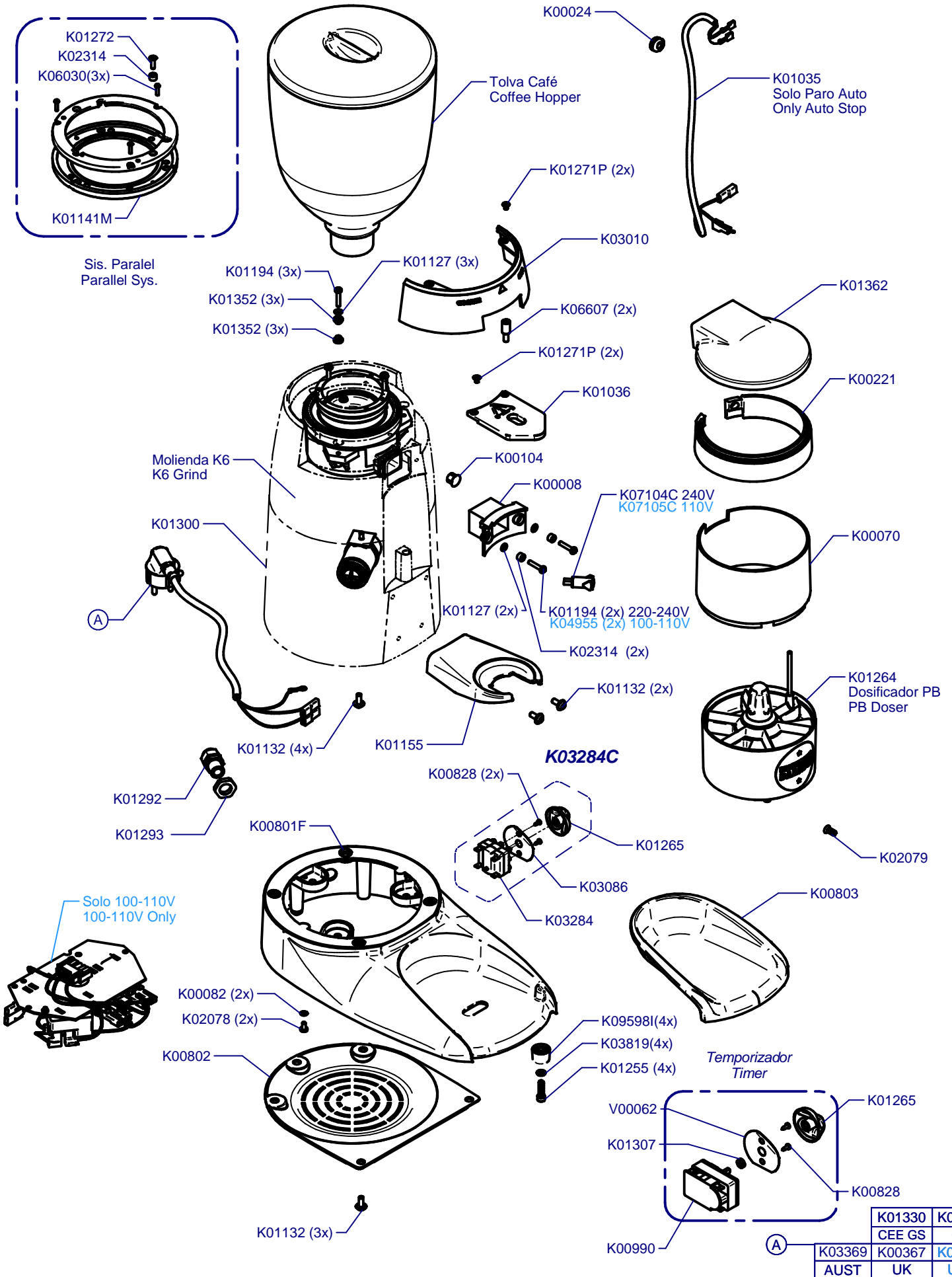

K01330	K00424
CEE GS	CH
K03369	K00367
AUST	UK
	K00113
	USA

Dosificador Aluminio/ Aluminium Doser

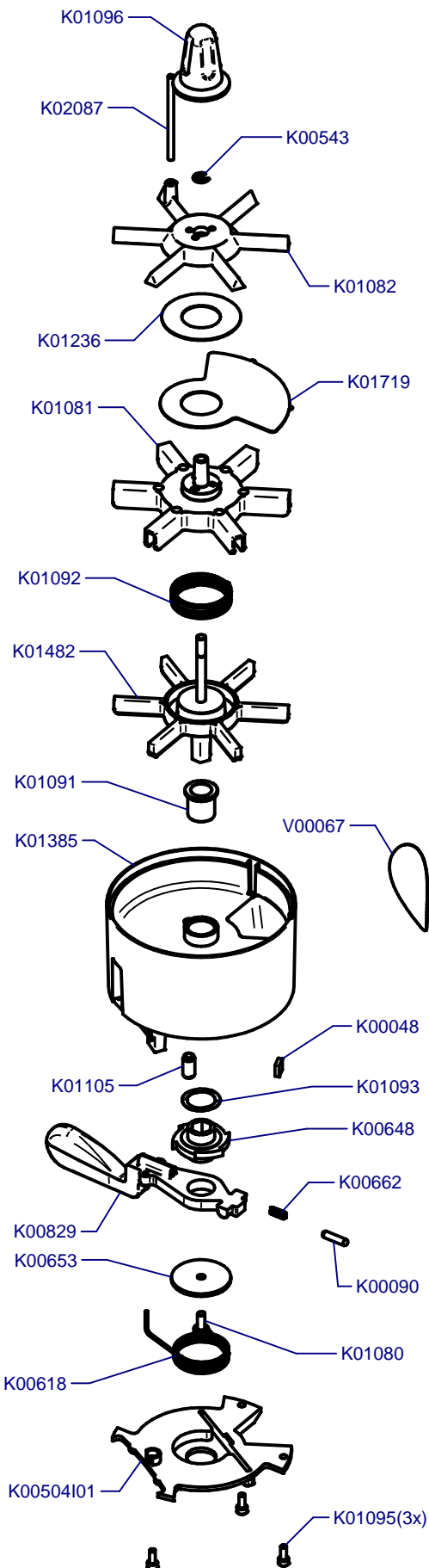

Tolva Café / Coffee Hopper

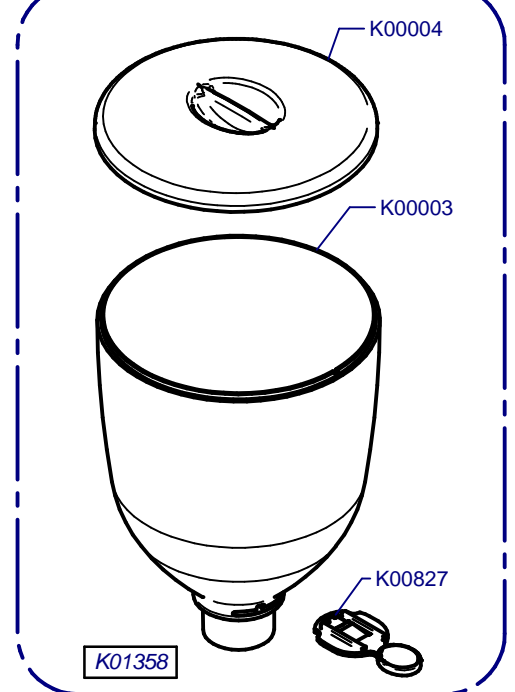

Tolva Café 275gr / Coffee Hopper 275gr

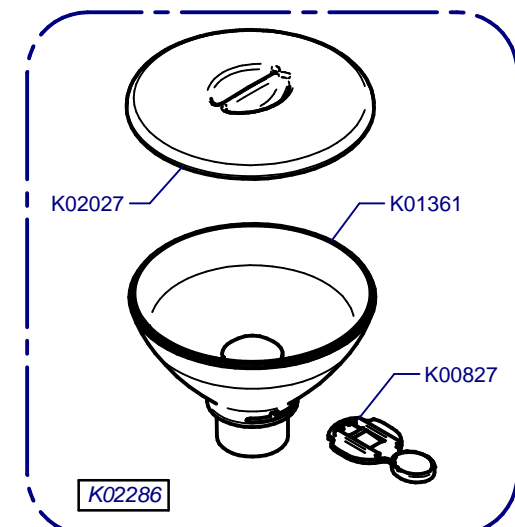

Paro Automático / Auto Stop

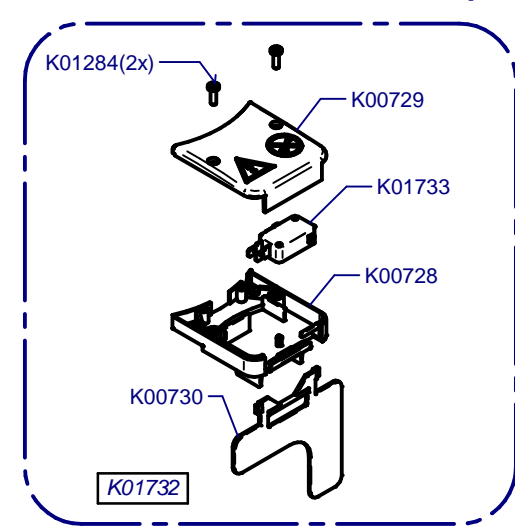

K6 Professional Barista

Updated 13/04/2022

Molienda / Grind

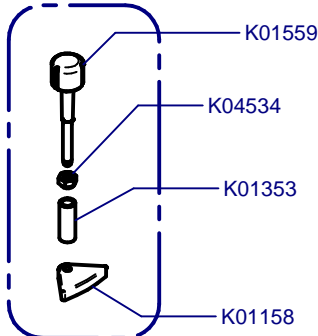

Sis. Paralel
Parallel Sys.

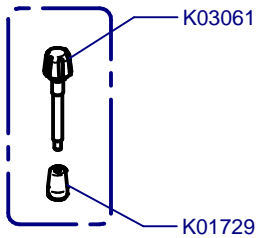

Sis. Micrometric
Micrometric Sys.

(*) Sis. Punto a Punto
Stepped Sys.

100-110V 50-60Hz

